

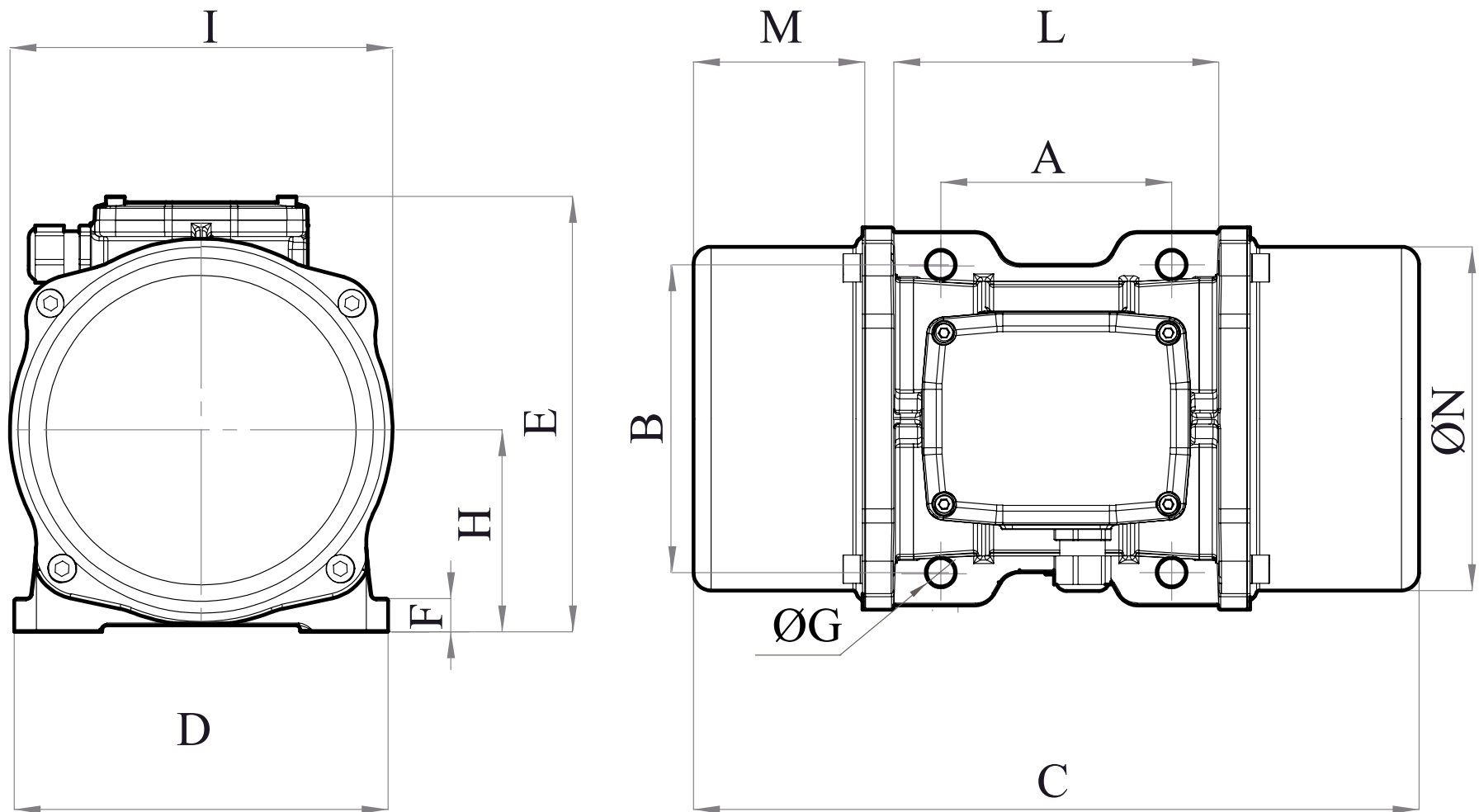

VEV 3000/15E-70A0

3 PH - 4 poles - 1500 RPM - 220-240/380-415 V - 50 Hz

Working moment [Kg*cm]	Unbalance [Kg*cm]	Centrifugal force [Kg]	Nominal voltage [V]	Input power [kW]	Current [A]	Power Factor	Ia/In
248,66	124,33	3.124	220-240/380-415	1,9	Δ 6,37 Y 3,68	0,75	6,7



OVERALL DIMENSIONS [mm]													
Weight [Kg]	A	B	G	Holes number	C	D	E	F	H	I	L	M	N
84	155	225	22	4	535	275	290	30	140	256	250	140	236

TECHNICAL FEATURES						
Type of grease	Greased for life	Screw	Washer	Clamping torque [Nm]	Cable type	Cable gland
MOBILITH SHC 100	Yes	M20	21 x 37 mm	373	4G4 120°C	M25 120°C

BEARINGS				
Bearing model	Type	Life 100%	Life 80%	Life 50%
NJ 2309		11530	24259	>100000

CERTIFICATION	
ATEX II2 D Ex tb IIIC Tx Db IP66 IECEx Ex tb IIIC Tx Db IP66 CLASS II DIV.2 GROUP F,G T4 Ex tb IIIC Tx Db IP66 [Tx Size Micro,10-30:100°C - Tx Size 40-91:135°C] CONFTO UL1004-3, UL1004-1, UL 60079-0, UL60079-31 CERT. CSA C22.2 No.100, CSA C22.2 No.77, CSA C22.2N.60079-0, CSA C22.2N.60079-31 T.Amb -20/+40°C	